

MultiGrid™: Electro, Instrumentation & Telecom

Various Angle Brackets fits all channels

Also see page 66.



Other Fixing Clamps for Ladders and Trays see our product catalogues.

Fits all

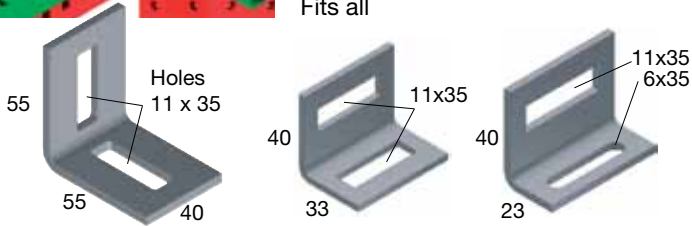

Material thickness: 4 mm.

Material thickness: 3 mm.

Fixing Clamps

For fastening ladders to brackets and supports.
Gives a safe earth connection between ladder and bracket.

Type	HDG Art. no.	SS Art. no.	Weight SS (kg)
S-M AB 55x55-10	1302494	1371712	0.11
OE-FC-A40x33-10/10	89908	89907	0.14
OE-FC-A40x23-10/6	89917	89916	0.05

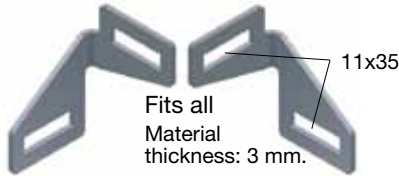
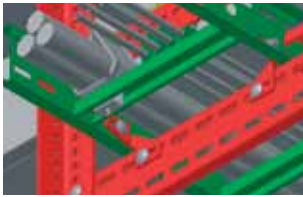

Fits all
Material thickness: 3 mm.

Fixing Clamp for channel-traverse. **Supplied in pairs.**

Type	HDG Art. no.	SS Art. no.	Weight SS (kg)
OE FC-CHM10	1302482	1371705	0.3



Fixing Clamp for traverse channels

Type	HDG Art. no.	SS Art. no.	Weight SS (kg)
S-M FC-CH	1302483	1302598	0.07

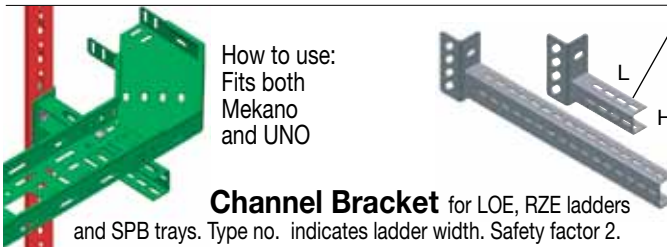

How to use:
Fits both
Mekano
and UNO

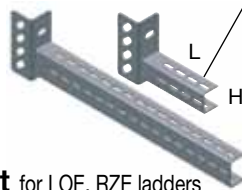

Channel Bracket for LOE, RZE ladders and SPB trays. Type no. indicates ladder width. Safety factor 2.

Type	H + L	HDG Art. no.	SS Art. no.	Maks last Max. load	Weight SS
S-M CB-30-100	38 + 129	1302437	1371791	180 kg	0.36 kg
S-M CB-30-150	38 + 179	1302438	1371792	180 kg	0.42 kg
S-M CB-30-200	38 + 229	1302439	1371793	200 kg	0.48 kg
S-M CB-30-300	50 + 329	1302440	1371794	200 kg	0.67 kg
S-M CB-30-400	50 + 429	1302441	1371799	200 kg	0.81 kg

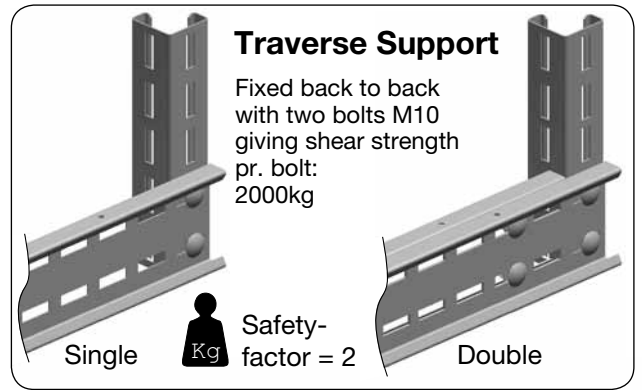

Single



Safety-factor = 2

Double

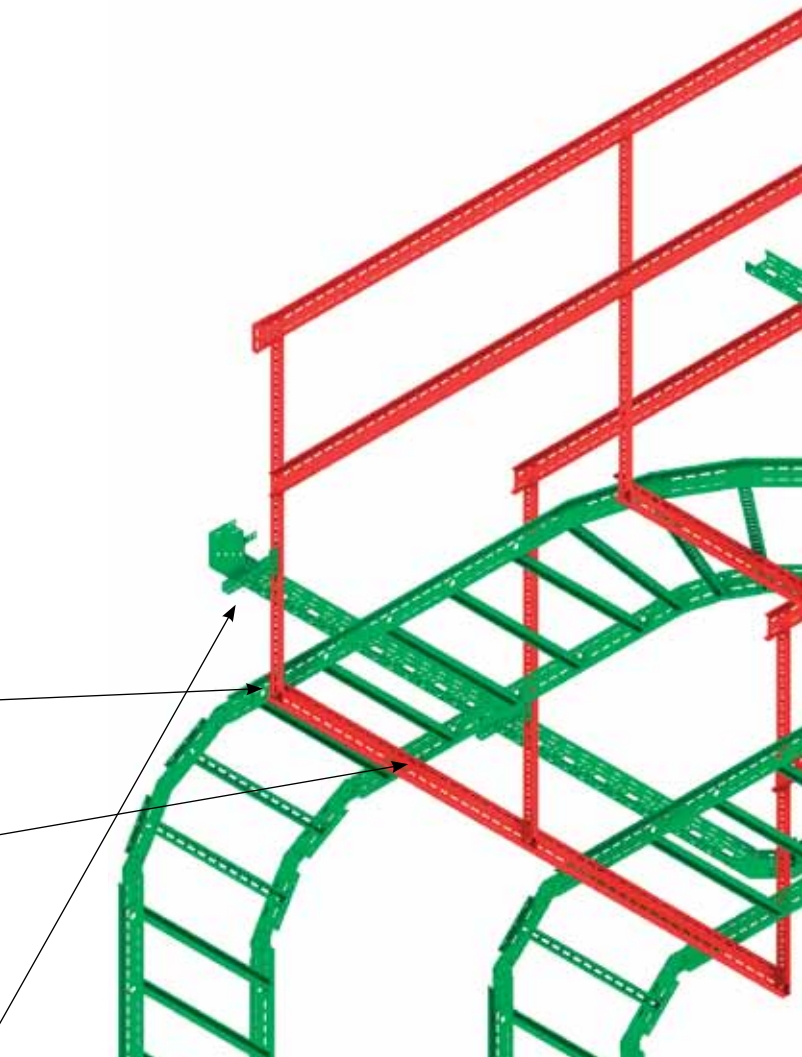

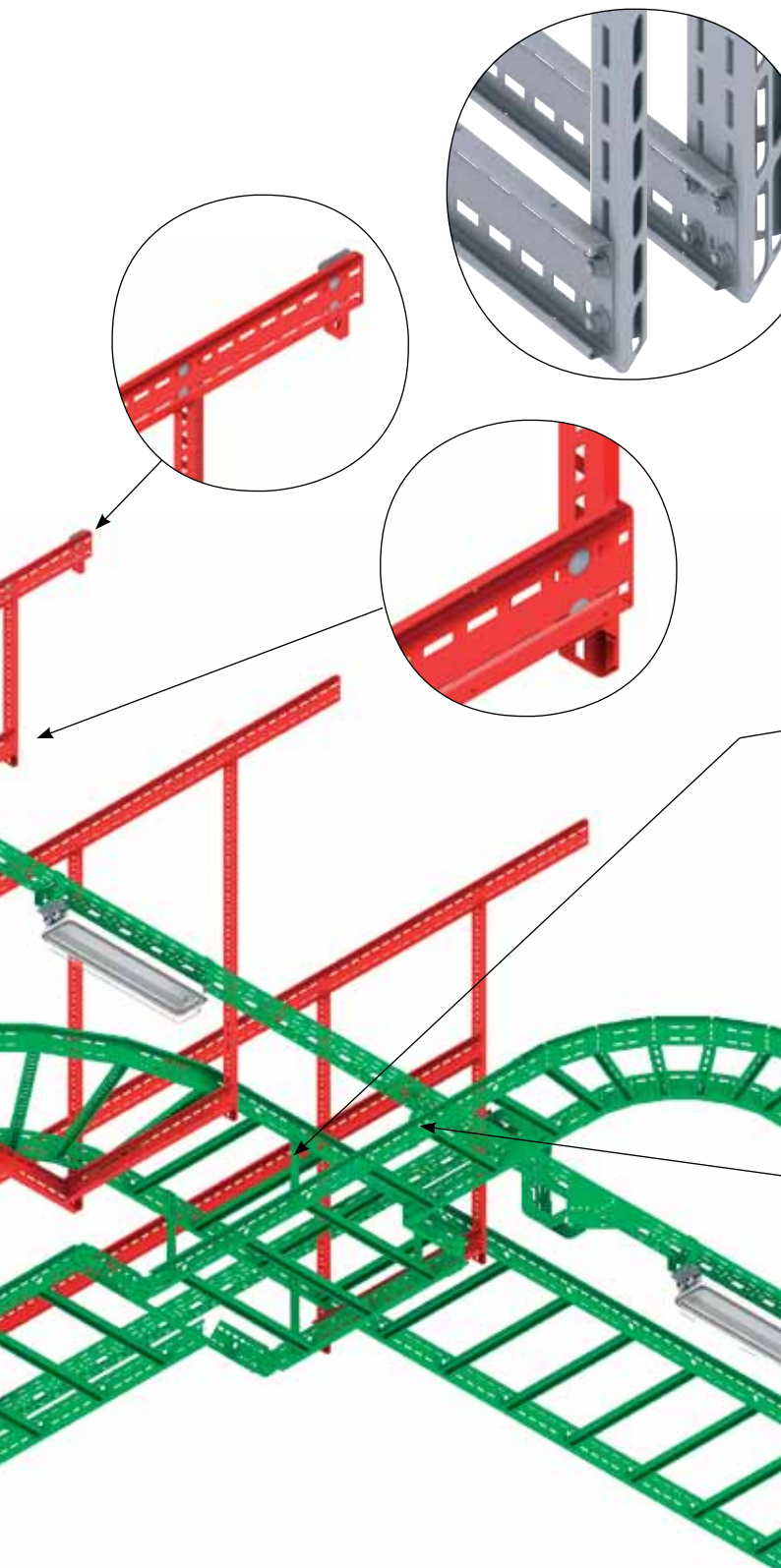

Choose channels according to the required load capacity.

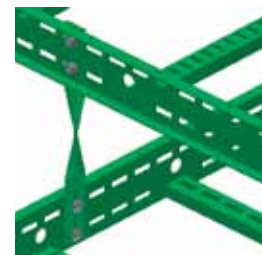

SC-TW 40/390

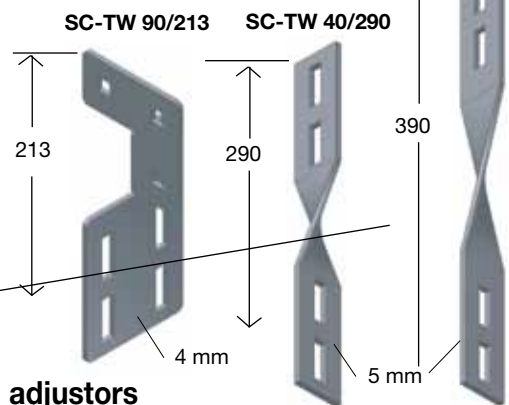

Directional adjusters

Type	HDG Art. no.	SS Art. no.	Weight SS (kg)
S-M SC-TW 90/213	1302515	1371700	0.5
S-M SC-TW 40/290	1302517	1371702	0.4
S-M SC-TW 40/390	84167	84168	0.6



Channel Bracket Twisted

Type	HDG Art. no.	SS Art. no.	Weight SS (kg)
S-SPB CB-TW	1302172	1371818	0.27

Gives a clean and professional installation with no descenders.
Fits all Mekano Channels.

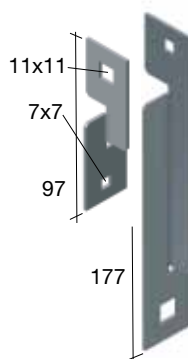

Interface between tray and OE-ladder

Type	HDG Art. no.	SS Art. no.	Weight SS (kg)
S-OE/SPB-RF-IF-97		85082	0.04
S-OE/SPB-RF-IF-177		60381	0.06

Angle Brackets Fit all channels

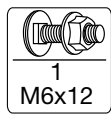

Material thickness: 5 mm.

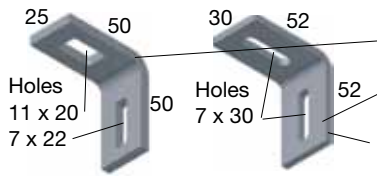

Type	HDG Art. no.	SS Art. no.	Weight SS (kg)
S-M AB 50x50-10/6	1372761	1371817	0.1
S-M AB 50x50-6	83410	84386	0.1

Material thickness: 4 mm.

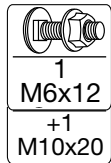

Material thickness: 4 mm.

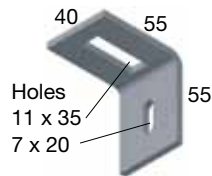

S-M AB 55x55-10/6	1302170	1371816	0.2
-------------------	---------	---------	-----

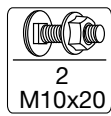

Material thickness: 4 mm.

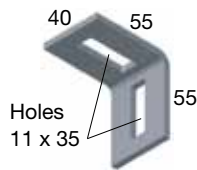

S-M AB 55x55-10	1302494	1371712	0.2
-----------------	---------	---------	-----

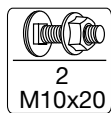

Material thickness: 5 mm.

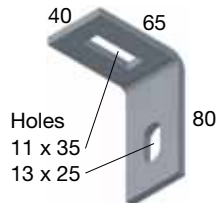

S-M AB 65x80-10/12	1372759	1371713	0.2
--------------------	---------	---------	-----

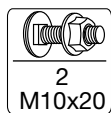

Material thickness: 5 mm.

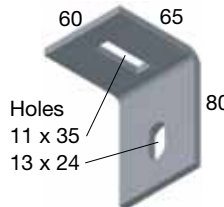

S-M AB 65x80-10/12B	1372762	1371714	0.3
---------------------	---------	---------	-----

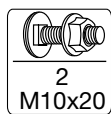

Material thickness: 5 mm.

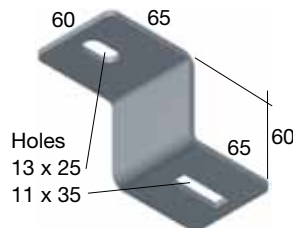

S-M AB 65x60-Z	1302501	1371715	0.3
----------------	---------	---------	-----

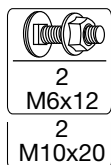

Material thickness: 5 mm.
For kombinasjon av 6 og 10mm skruer.
To combine 6 and 10mm bolts.

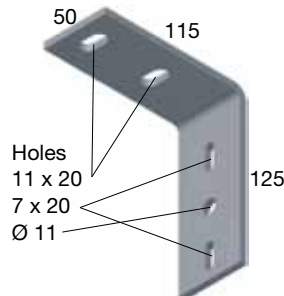

S-M AB 110x120-10/6	1302503	1371717	0.5
---------------------	---------	---------	-----

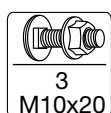

Material thickness: 5 mm.

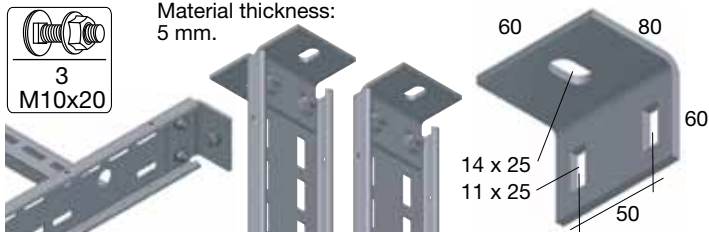

End piece for Channel S-M CH100-1-3000

Type	HDG Art. no.	SS Art. no.	Weight SS (kg)
S-M AB 60x60-10/12	1302502	1371716	0.3

Various Items

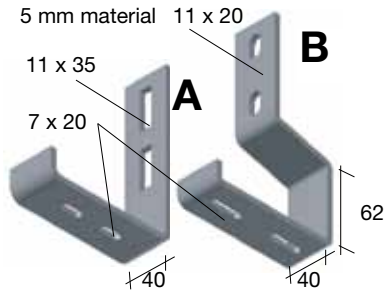
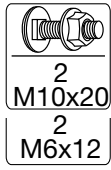

A: Cantilever Arm for 100 mm tray
B: Channel Bracket for 100 mm tray

Type	HDG Art. no.	SS Art. no.	AL Art. no.	Weight SS (kg)
S-SPB CA-100	1302320	1302323		0.4 kg
S-SPB CB-100	1302216	1302218		0.3 kg

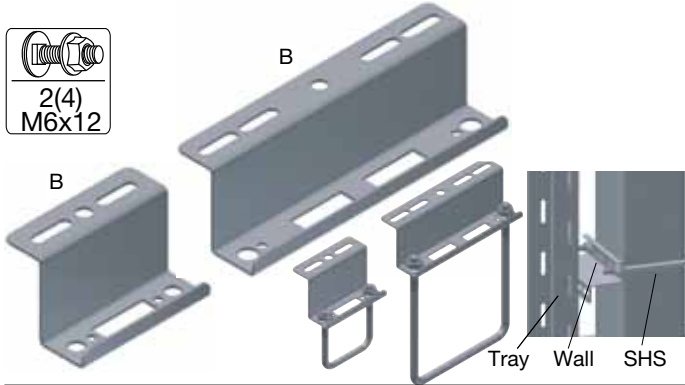

SPB Wall Support Bracket

Type states tray width B and type SHS it will fit using a square U-bolt. See page 79 ordering U-bolts. SHS: Square Hollow Section. Can also be mounted directly to a wall.

Type	Fits SHS	HDG Art. no.	SS Art. no.	Weight SS (kg)
S-SPB SB-85-SHS-50		1302150	1371795	0.12
S-SPB SB-111-SHS-80*		1302154	1371800	0.15
S-SPB SB-135-SHS-100		1302151	1371796	0.18
S-SPB SB-155-SHS-120		1302152	1371797	0.40
S-SPB SB-175-SHS-140		1302153	1371798	0.45

*) Fits tray width 100-150

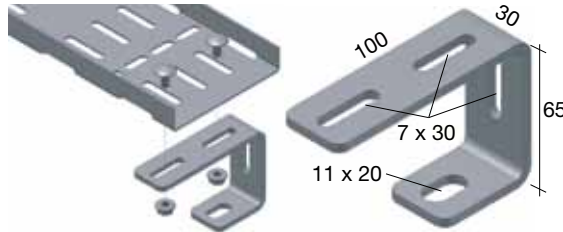
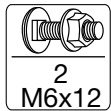

Tray Bracket for SPBE/SPB-RF-100

Type	HDG Art. no.	SS Art. no.	AL Art. no.	Weight SS
S-SPB SB-STUD	1372902	1372903		

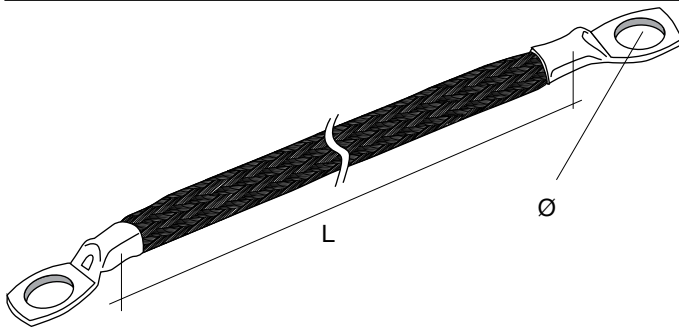

Earth Link "Jumpers"

Type	Art. no.	L Length mm	Ø Screw	Cross section mm ²
A-M EL-100/6-4	85813	100	6	4
A-M EL-100/6-6	85814	100	6	6
A-M EL-100/10-10	85815	100	10	10
A-M EL-300/10-10	85816	300	10	10
A-M EL-100/10-16	85817	100	10	16
A-M EL-300/10-16	85818	300	10	16

Other dimensions on request.

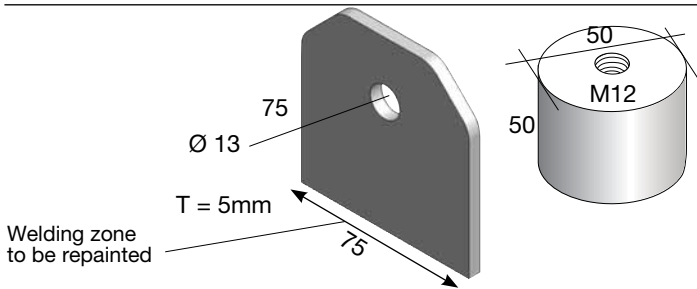

Earthing Boss

Type	CS Art. no.	SS Art. no.	SS Weight
A-M EB-EL-50x50x12	83427	83428	0.8 kg

Earthing Lug

Type	Art. no.	Weight
A-M WB-EL	87640	0.2 kg

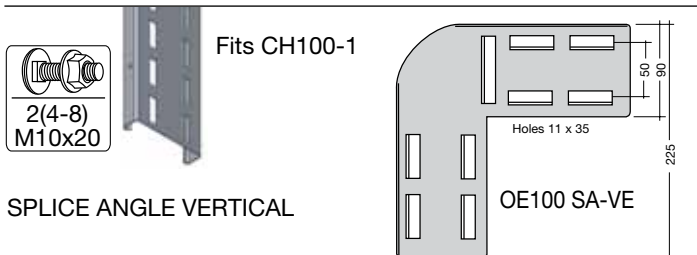

SPLICE ANGLE VERTICAL

Splice Connectors for channels

For Mekano channel S-M CH100-1

Type	HDG Art. no.	SS Art. no.	Weight SS (kg)
OE100 SA-VE	1302493	1371711	0.8

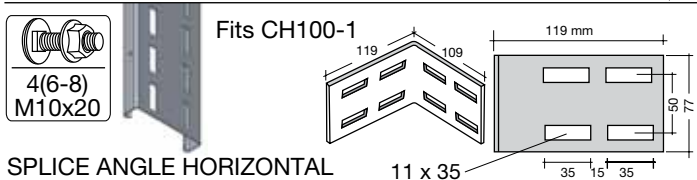

SPLICE ANGLE HORIZONTAL

Splice Connectors for channels

For Mekano channel S-M CH100-1

Type	HDG Art. no.	SS Art. no.	Weight SS (kg)
OE100 SA-HO	1302534	1371682	0.7